







Kombinationsbeispiel

Trampolin modulus circle 60

Art.Nr. 7231101

Technische Spezifikationen siehe unten.

Effektive Sprungfläche ca. 6 x 0,71 x 0,64 m.

-  Ø 3,70 m
-  Ø 6,20 m
-  0,0 m
-  ab 3 Jahre
-  0,55 m
-  1050 kg
-  keine

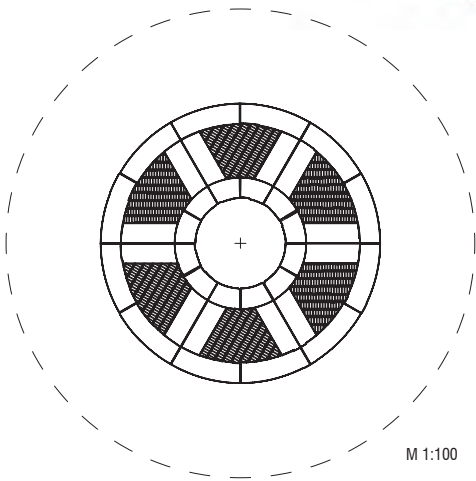

Architekten-Tipp!
Sonderfarben der Sprungmatte und der Fallschutzelemente sind möglich! Bitte kontaktieren Sie uns im Bedarfsfall.

